

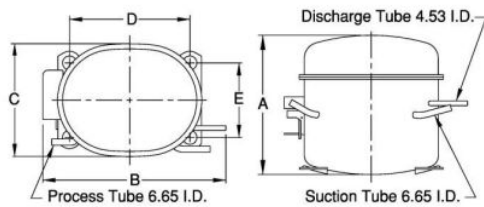

PRINCIPAL DIMENSIONS - mm



A: 216	B: 277	C: 155	D: 165	E: 102
--------	--------	--------	--------	--------

SCHEMATIC WIRING DIAGRAM C.S.R.

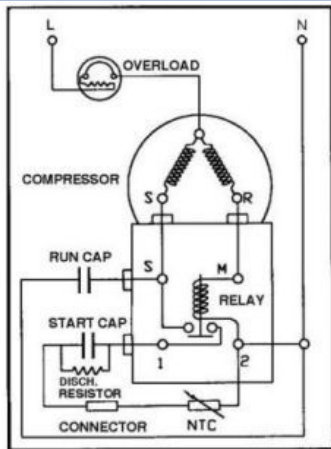

SCHEMATIC WIRING DIAGRAM -

MOUNTING KIT

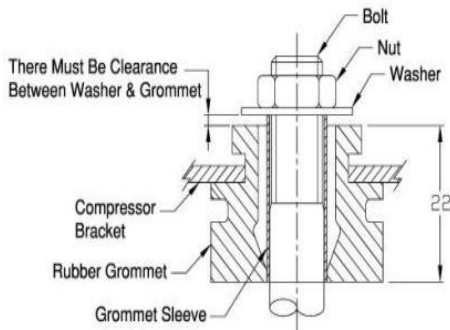

Electrical : 220-240 V/50 Hz. 1 Phase

Nominal Performance

Capacity	613 / - Watts
	2,092 / - BTU/Hr
	527 / - Kcal/Hr
Power Input	488 / - Watts
Locked Rotor Amps	16.30 / - Amps
Max Continuous Current	- / - Amps
Rated Load Amps	2.71 / - Amps
COP	1.26 / - Watts / Watts
EER	4.29 / - BTU/W-Hr

Testing Conditions

Condensing Temperature	54.40 °C	129.9 °F
Evaporating Temperature	-23.30 / - °C	-9.9 / - °F
Liquid Temperature	32.20 °C	90.0 °F
Return Gas Temperature	32.20 °C	90.0 °F
Ambient Temperature	32.20 °C	90.0 °F

Application

Evaporating Temp. Range	LBP	@ -40.00 ° C to -12.20 ° C (-40.0° F to 10.0° F)
	Heat Pump	- ° C to - ° C (-° F to -° F)
Refrigerant	R404A/R507	
Refrigerant Flow Control	Capillary Tube	
Compressor Cooling	Fan	

Compressor and Motor data

Compressor Type	Reciprocating
Displacement	14.14 cc.
Oil Type	Polyolester Oil
Oil Charge	537 cc.
Motor Type	C.S.R. ; 2 Pole 2,880 / - r/m
Voltage Range	187 - 264/- Volts 50/- Hz.
Winding Resistance at 25 ° C	
Start	10.00 Ohms
Run	4.40 Ohms
Weight with Oil	11.75 Kg.
Weight with Oil and Accessories	12.14 Kg.

Electrical Components

Motor Protector	
Type	External 3/4"
Model Number	KME 660-8/C
Open / Close	100-110 / 78-60 ° C
1st Cycle trip at 25 ° C	- Amps(main) 11.00 Amps(start)
Motor Starter	
Type	Current Relay
Model Number	KME 682-16NT
Pick Up (max.)	7.70 Amps
Drop Out (min.)	6.75 Amps
Terminal Cover	KMD 901-12
Start Capacitor	36-43 µF 330 VAC.
Disch Resistor for Start Cap	15000 Ohms 2 W
Run Capacitor	8 µF 450 VAC.

Mounting Kit

Rubber Grommet	KMD 905-3
Sleeve Grommet	KMD 903-2
Washer	KEB 387

Since we are constantly improving our product , the specification are subject to change without notice.

REV. DATE	C / N No.
05-10-12	0462/12

Certificate Marks

COMPRESSOR PERFORMANCE TABLE